

# 8BCM0025.1625B-0

## 1 General information

- UL/CSA listed
- Can be used in cable drag chains
- Assembled specifically for use with ACOPOSmulti drive systems and B&R servo motors with motor connector size 1.5
- Pre-assembled power line connections on the servo side with M8 ring terminal ends
- Integrated shield plate

### Information:

A shield plate is attached to ACOPOSmulti 8BCM motor cables. If this shield plate is correctly installed on the respective ACOPOSmulti 8BVI inverter module, no additional shielding measures are necessary.

## 2 Order data

Model number	Short description	Figure
	<b>16 mm<sup>2</sup> motor cables with ring terminal ends</b>	
8BCM0025.1625B-0	ACOPOSmulti motor cable, length 25 m, 4x 16 mm <sup>2</sup> + 2x 1.5 mm <sup>2</sup> + 2x 0.75 mm <sup>2</sup> , 8-pin female motor connector size 1.5, integrated shield plate, M8 ring terminal end on servo side, can be used in cable drag chains, UL/CSA listed	

Table 1: 8BCM0025.1625B-0 - Order data

## 3 Technical data

Model number	8BCM0025.1625B-0
<b>General information</b>	
Note	Pre-assembled power line connections on the servo side with M8 ring terminal ends
Cable cross section	4x 16 mm <sup>2</sup> + 2x 1.5 mm <sup>2</sup> + 2x 0.75 mm <sup>2</sup>
Durability	Oil resistant per DIN EN 60811 -404 <sup>1)</sup>
Certification	UL AWM STYLE 20234, 80°C, 1000 V, E63216 as well as CSA AWM I/II A/B, 90°C, 1000 V, FT1 LL46064 <sup>1)</sup>
Certifications	
CE	Yes
UL	cULus E225616 Power conversion equipment
<b>Cable construction</b>	
Power lines	
Quantity	4
Wire insulation	Special thermoplastic material
Wire colors	Black, yellow/green
Design	Tinned copper stranded wire
Cross section	16 mm <sup>2</sup>
Shield	No
Stranding	No
Signal lines	
Quantity	4
Wire insulation	Special thermoplastic material
Wire colors	White/Blue, white/green, white, white/red
Design	Tinned copper stranded wire
Cross section	2x 1.5 mm <sup>2</sup> + 2x 0.75 mm <sup>2</sup>
Shield	Separate shielding for pairs, tinned copper braiding, optical coverage >85% and foil shield
Stranding	White with white/red and white/blue with white/green
Cable stranding	With filler elements and foil shield
Complete shielding	Tinned copper braiding, optical coverage >85% and foil shield

Table 2: 8BCM0025.1625B-0 - Technical data

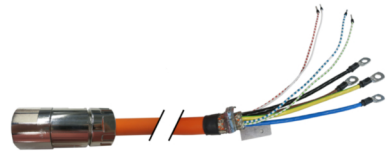
Model number	8BCM0025.1625B-0
Outer jacket	
Material	PUR
Color	Orange, similar to RAL 2003 flat
Labeling	B&R 4x16.0 + 1x2x0.75 + 1x2x1.5 FLEX (UL) AWM STYLE 20234 80°C 1000 V E63216 CSA AWM I/II A/B 90°C 1000 V FT1 LL46064 <sup>1)</sup>
<b>Connector</b>	
Type	Intercontec 8-pin female motor connector, size 1.5
Connection cycles	<500
Contacts	8 (4 power and 4 signal contacts)
Degree of protection per EN 60529	IP66/67 when connected
<b>Electrical characteristics <sup>1)</sup></b>	
Operating voltage	Max. 1000 V AC (UL)
Test voltage	
Wire/Wire	3 kV
Wire/Shield	3 kV
Conductor resistance	
Power lines	≤1.2 Ω/km
Signal lines	0.75 mm <sup>2</sup> : ≤29 Ω/km, 1.5 mm <sup>2</sup> : ≤14 Ω/km
Insulation resistance	>200 MΩ*km
Current-carrying capacity per DIN VDE 0298 part 4, table 11	
Wall mounting	64.6 A
Installed in conduit or cable duct	54.6 A
Installed in cable tray	68.3 A
Max. current load per IEC 60364-5-52 (cable) and IEC 60512 (connector) <sup>2)</sup>	68 A <sup>3)</sup>
<b>Environmental conditions <sup>1)</sup></b>	
Temperature	
Moving	-20°C to +80°C
Static	-20°C to +80°C
<b>Mechanical characteristics <sup>1)</sup></b>	
Dimensions	
Length	25 m
Diameter	24.2 mm ± 0.8 mm
Bend radius	
Single bend	≥75 mm
Moving	≥188 mm
Drag chain data	
Acceleration	≤6 g
Flex cycles <sup>4)</sup>	>3,000,000
Speed	≤4 m/s
Weight	28.5 kg

Table 2: 8BCM0025.1625B-0 - Technical data

- 1) Values refer to the raw cable being used.
- 2) Rated current at 40°C. Use at higher temperatures is possible with derating.
- 3) It is recommended to leave a reserve of 15%.
- 4) At an ambient temperature of 20°C and bend radius of 185 mm.

## 4 Wiring

### Construction

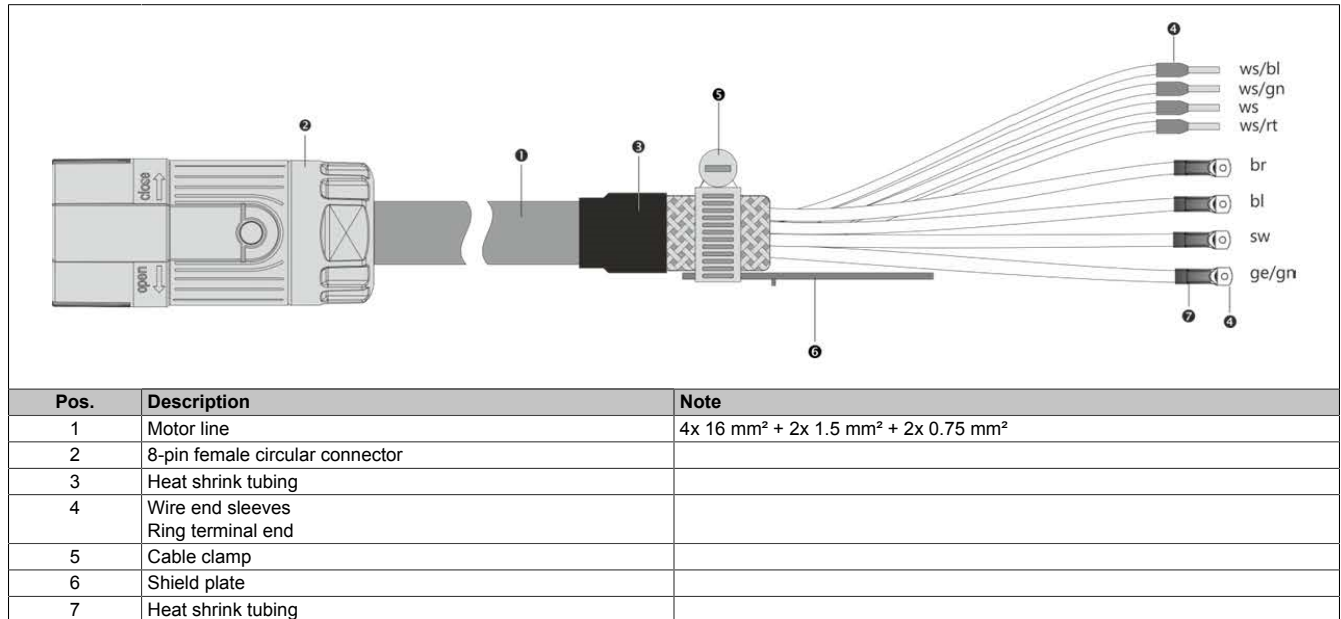

Table 3: 8BCMxxxx.1625B-0 motor cables - Construction

### Pinout

Circular connector	Pin	Description	Function
	U	U	Motor connection U
	⊥	PE	Protective ground conductor
	W	W	Motor connection W
	V	V	Motor connection V
	1	T+	Temperature +
	2	T-	Temperature -
	+	B+	Brake +
	-	B-	Brake -

Table 4: 8BCMxxxx.1625B-0 motor cables - Pinout

### Cable diagram

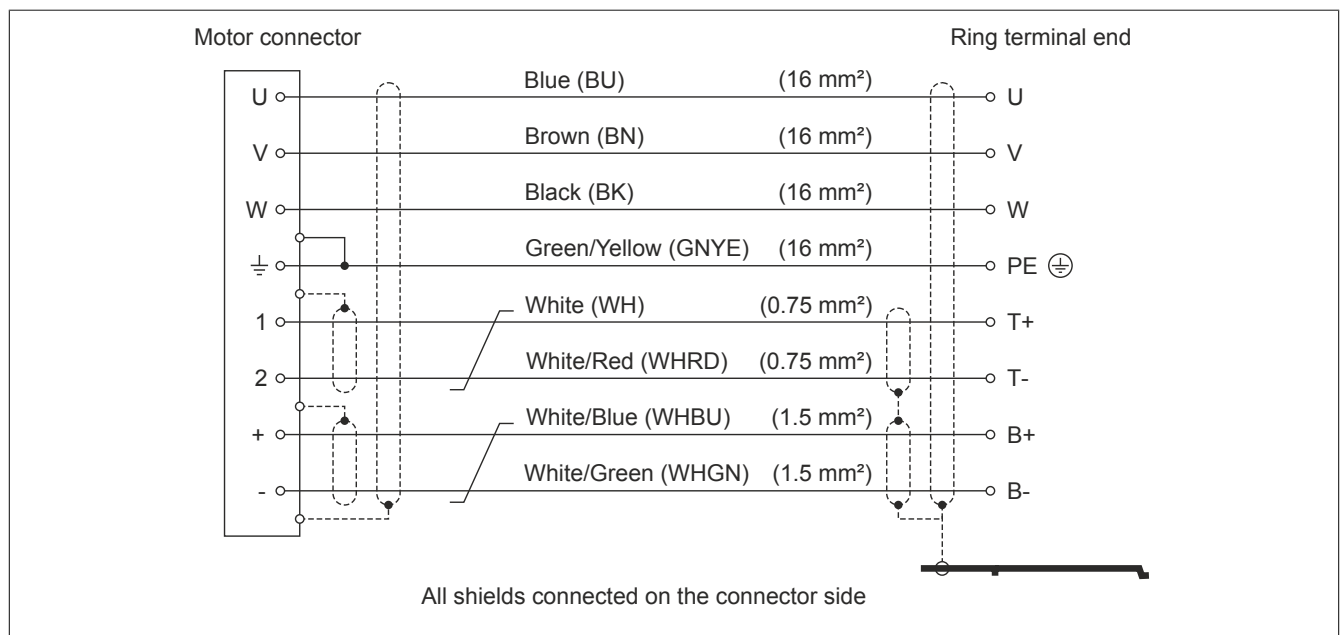

Figure 1: 8BCMxxxx.1625B-0 motor cables - Cable diagram