

8BCM0024.1322A-0

1 General information

- Can be used in cable drag chains
- Assembled specifically for use with ACOPOSmulti drive systems and B&R servo motors with motor connector size 1.5
- speedtec - Innovative connector system for secure connections
- Integrated shield plate

Information:

A shield plate is attached to ACOPOSmulti 8BCM motor cables. If this shield plate is correctly installed on the respective ACOPOSmulti 8BVI inverter module, no additional shielding measures are necessary.

2 Order data

Model number	Short description	Figure
8BCM0024.1322A-0	4 mm ² motor cables with size 1.5 motor connector ACOPOSmulti motor cable, length 24 m, 4x 4 mm ² + 2x 0.75 mm ² + 2x 1 mm ² , 8-pin female speedtec motor connector size 1.5, integrated shield plate, can be used in cable drag chains	

Table 1: 8BCM0024.1322A-0 - Order data

3 Technical data

Model number	8BCM0024.1322A-0
General information	
Cable cross section	4 x 4.0 mm ² + 2 x 0.75 mm ² + 2 x 1.0 mm ²
Durability	Oil resistance per HD 22.10 appendix A and DIN EN 60811-404 ¹⁾
Certification	E170315 cRUus AWM STYLE 21223 AWM I/II A/B 80°C 1000 V FT1 ¹⁾
Certifications	
CE	Yes
UL	cULus E225616 Power conversion equipment
EAC	Yes
Cable construction	
Power lines	
Quantity	4
Wire insulation	PP
Wire colors	Black, brown, blue, yellow/green
Variant	Tinned copper stranded wire
Cross section	4 mm ²
Shield	No
Stranding	No
Signal line	
Quantity	4
Wire insulation	PP
Wire colors	White, white/red, white/blue, white/green
Variant	Tinned copper stranded wire
Cross section	2 x 0.75 mm ² + 2 x 1.0 mm ²
Shield	Separate shielding for pairs, tinned copper braiding, optical coverage >85% and foil shield
Stranding	White with white/red and white/blue with white/green
Cable stranding	With filler elements and foil shield
Cable shield	Tinned copper braiding, optical coverage >85% and foil shield
Outer jacket	
Material	TPU
Color	Orange, similar to RAL 2003 flat
Labeling	B&R 4 G 4 + (2x0.75)C + (2x1)C C E170315 cRUus AWM STYLE 21223 AWM I/II A/B 80°C 1000 V FT1 ¹⁾
Connector	
Type	8-pin female speedtec motor connector, size 1.5

Table 2: 8BCM0024.1322A-0 - Technical data

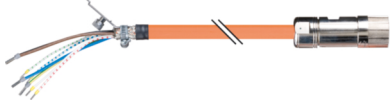
Model number	8BCM0024.1322A-0
Mating cycles	<500
Contacts	8 (4 power and 4 signal contacts)
Degree of protection per EN 60529	IP66/67 when connected
Electrical properties ¹⁾	
Operating voltage	Max. 1000 V AC (UL)
Test voltage	
Wire - Wire	4 kV
Wire - Shield	4 kV
Conductor resistance	
Power lines	≤5.1 Ω/km
Signal line	0.75 mm ² : ≤26.7 Ω/km, 1 mm ² : ≤20 Ω/km
Insulation resistance	≥500 MΩ*km
Current-carrying capacity per DIN VDE 0298 part 4, table 11	
Wall mounting	30 A ²⁾
Installed in conduit or cable duct	30 A ²⁾
Installed in cable tray	30 A ²⁾
Ambient conditions ¹⁾	
Temperature	
Moving	-20°C to +80°C
Static	-20°C to +90°C
Mechanical properties ¹⁾	
Dimensions	
Length	24 m
Diameter	15.4 mm ± 0.4 mm
Bend radius	
Single bend	>48 mm
Moving	>119 mm
Drag chain data	
Acceleration	Max. 50 m/s ² (depends on the length of the travel path)
Flex cycles ³⁾	≥5,000,000
Velocity	Max. 300 m/min
Weight	6.7 kg

Table 2: 8BCM0024.1322A-0 - Technical data

- 1) Values refer to the raw cable being used.
2) Limited to 30 A by the motor connector.
3) At an ambient temperature from -20°C to +60°C.

4 4 mm² motor cables with size 1.5 connector

Construction

Pos.	Description	Note
1	Motor line	4x 4 mm ² + 2x 0.75 mm ² + 2x 1 mm ²
2	8-pin female circular connector	Dimensions: ø 46 x 99 mm
3	Heat shrink tubing	
4	Wire end sleeves	
5	Cable clamp	
6	Shield plate	

Table 3: 4 mm² motor cables with size 1.5 connector - Construction

Pinout

Circular connector	Pin	Description	Function
	U	U	Motor connection U
	⊥	PE	Protective ground conductor
	W	W	Motor connection W
	V	V	Motor connection V
	1	T+	Temperature +
	2	T-	Temperature -
	+	B+	Brake +
	-	B-	Brake -

Table 4: 4 mm² motor cables with size 1.5 connector - Pinout

Cable diagram

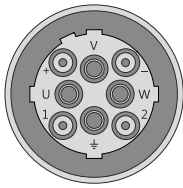
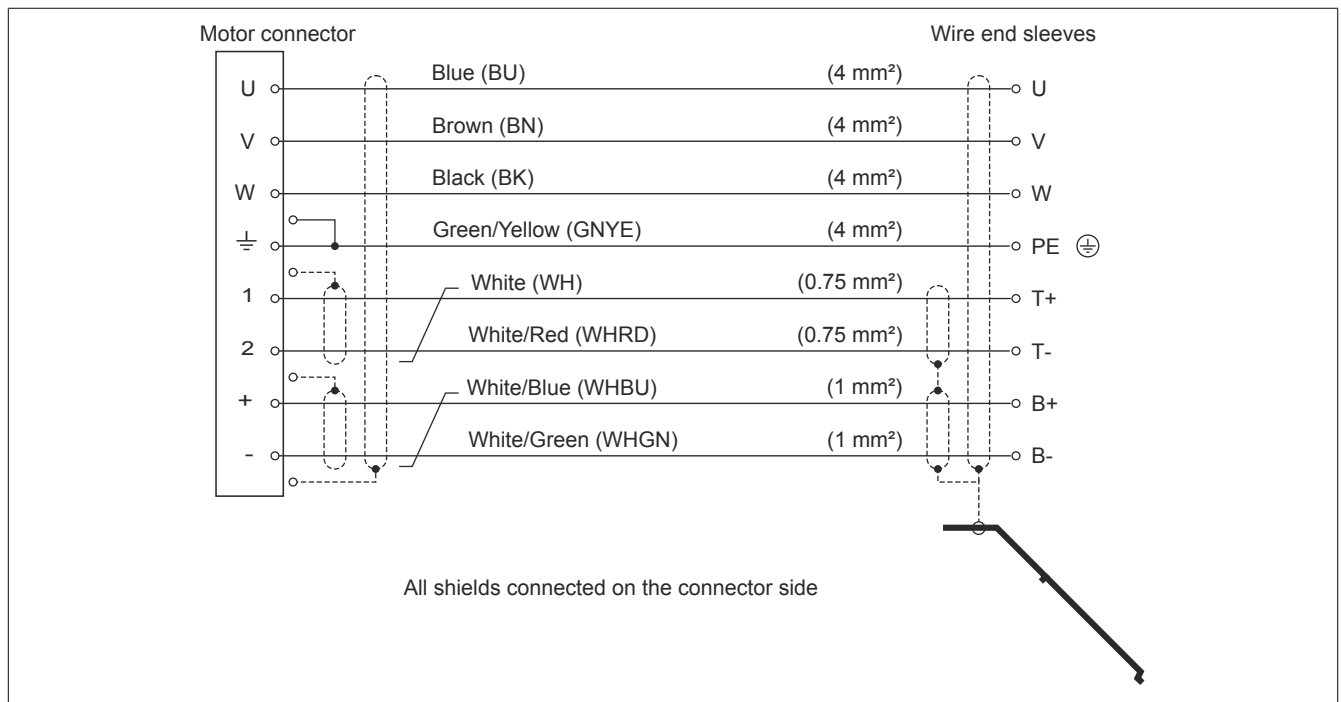

Figure 1: 4 mm² motor cables with size 1.5 connector - Cable diagram